

# CHERRYMAX® PROCESS MANUAL

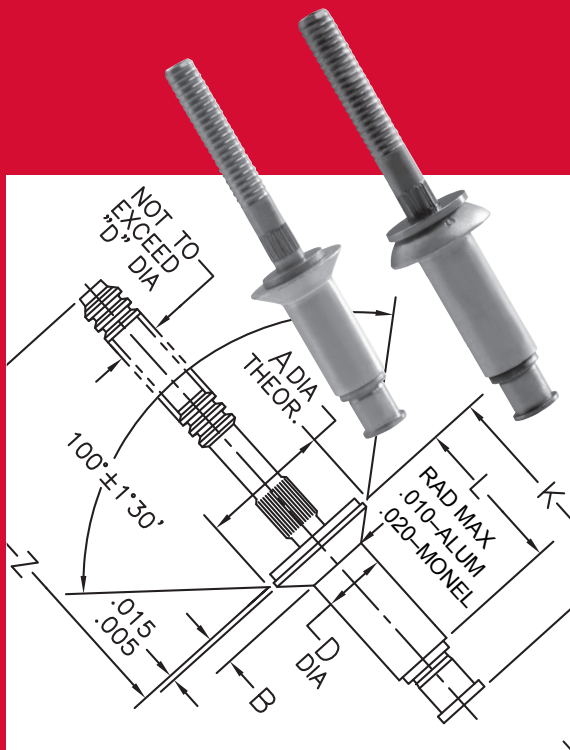

**CHERRY®**  
**AEROSPACE**

SPS Fastener Division, a PCC Company



# CONTENTS

Product Description .....	2
CherryMAX® Rivet Features .....	2
CherryMAX® Rivet Benefits .....	2
Rivet Availability .....	3
Tooling Availability.....	3
Installation Sequence .....	3
CherryMAX® Rivet Selection.....	4
CherryMAX® Tool Selection.....	5
CherryMAX® Installation .....	6
Hole Preparation .....	7
Correct Grip Measurement .....	11
Proper Sealant Application .....	12
Rivet Shaving.....	13
Inspection of Installed CherryMAX® Fasteners .....	13
Rivet Installation Troubleshooting .....	16
Rivet Removal .....	17
CherryMAX® Tooling .....	20
Extensions, Adapters & Accessories .....	22
Tool Troubleshooting .....	23
Service Accessories .....	25
Tool & Repair Service .....	25
Decimal Equivalent Chart.....	26
NAS vs. CherryMAX® Cross-Reference List.....	27

*For assistance or further information call  
Cherry Aerospace Technical Services at 714-850-6022  
or visit [www.cherryaerospace.com](http://www.cherryaerospace.com).*

# PRODUCT DESCRIPTION

## CHERRYMAX® RIVET FEATURES

The CherryMAX® rivet is a reliable, high strength structural fastener widely used in the aircraft industry. It features the “safe-lock” locking collar for reliable joint integrity. It meets the requirements of PS-CMR-3000.

A CherryMAX® rivet consists of four components:

1. A fully serrated stem with break notch, shear ring and integral grip adjustment
2. A driving anvil which acts as a tool, setting the locking collar in place
3. A locking collar that mechanically locks the stem to the rivet sleeve during fastener installation
4. A rivet sleeve

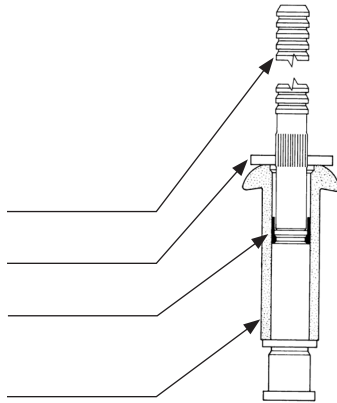

## CHERRYMAX® RIVET BENEFITS

### Simple tooling and increased tool life

The driving anvil acts as a setting tool increasing the tool life and allowing the installation of multiple sizes (4,5 and 6 diameters) with one tool.

### Visual Inspectability

The CherryMAX® rivet features a “safe-lock” locking collar which enhances joint integrity and reliability.

Correct installation can be assessed from the visible side due to two features: stem flushness and locking collar formation. This system is approved for use in engine inlets and components.

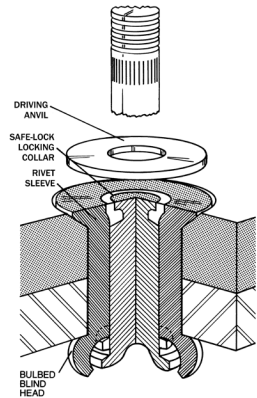

## RIVET AVAILABILITY

### MATERIALS

For 50KSI shear: 5056 aluminum rivet sleeve with Alloy or Corrosion Resistant Steel stem

For 75KSI shear: Monel rivet sleeve with Corrosion Resistant Steel stem; INCO 600 sleeve/INCO X-750 stem (for high temperature)

### DIAMETERS

1/8", 5/32", 3/16" and 1/4", nominal and oversize (.016" over nominal)

### HEAD STYLES

- Universal (button head)
- 100° Flush standard and reduced (NAS1097)
- 120° Flush
- Unisink

## TOOLING AVAILABILITY

A wide variety of tools are available for installing Cherrymax fasteners.

- Light, ergonomic riveters
- Various types of pulling heads for different applications:
  1. For areas with open access:
    - Straight Pulling heads
  2. For areas with limited access:
    - Right Angle
    - Offset pulling heads
    - Adaptor extensions
    - Split riveters

## INSTALLATION SEQUENCE

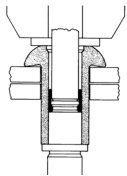

1. Insert rivet into the prepared hole and place pulling head over the stem, pushed against the driving anvil (washer).

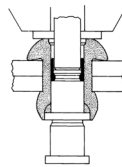

2. When riveter is actuated, the stem is pulled into the sleeve, deforming the blind end into a bulb.

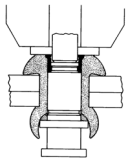

3. When the blind end bulb is fully formed, the "shear ring" of the stem shears, and starts moving down the stem allowing the stem to complete installation.

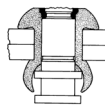

4. When hitting the driving anvil, the locking collar deforms and fills the rivet head recess, locking the sleeve and stem together. The stem then breaks and the top portion is discarded.

# CHERRYMAX® RIVET SELECTION

## NUMBERING SYSTEM

CR3243 -4 -04

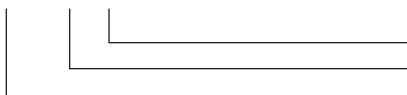

**Maximum Grip Length** (in 16" increments)  
**Rivet Diameter** (in 1/32" increments)  
**Head Style / Material Combination** (see table)

Head Style		Material Combination	
Countersunk Head	Universal Head	Rivet Material	Stem Material
Nominal CherryMAX®		Nominal CherryMAX®	
CR3212	CR3213	5056 AL	ALLOY STEEL
CR3222	CR3223	5056 AL	CRES
CR3522	CR3523	MONEL	CRES
Oversize CherryMAX®		Oversize CherryMAX®	
CR3242	CR3243	5056 AL	ALLOY STEEL
CR3252	CR3253	5056 AL	CRES
CR3552	CR3553	MONEL	CRES
CR3852	CR3853	INCO 600	INCO X-750

## GRIP LENGTH

The last dash number in the part number indicates the maximum grip in 1/16" increments (for example, -04 has a maximum grip of 4/16" = 1/4"). See tables below:

Rivet Grip No.	Material Thickness Range (in.)	
	Min	Max
-01	*	.062
-02	.062	.125
-03	.126	.187
-04	.188	.250
-05	.251	.312
-06	.313	.375
-07	.376	.437
-08	.438	.500
-09	.501	.562
-10	.563	.625
-11	.626	.687
-12	.688	.750

\*See -01 minimum grip guidelines.

-01 Minimum Grip Guidelines			
Rivet Dia	CherryMAX® Universal Head	CR3242 CR3252 CR3552 MS20426 Flush Head	CR3245 CR3255 CR3555 Unisink Head
1/8"	.025	.045	.033
5/32"	.031	N/A	N/A
3/16"	.037	N/A	N/A

**NOTE:** For double dimpled sheets, add countersink head height to material thickness.

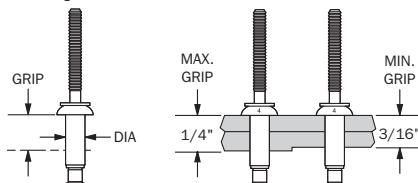

# CHERRYMAX® TOOL SELECTION

The shaded areas in the table below show the diameters that each tool / pulling head combination is capable of installing. Cherry recommends using a CherryMAX® single action riveter for best results.

For more information regarding installation tooling combinations, please contact the Cherry Technical Services at 714-850-6022.

Type of Riveter	Riveter Model	Pulling Head	Adaptor	All Grip Lengths								
				Nominal Dia.				Oversize Dia.				
				4	5	6	8	4	5	6	8	
Cherrymax, Single Action	G27 <sup>3</sup>	Included	None									
		H701B-456	None									
	G747, G704B, G800 <sup>3</sup>	H747-456	None									
		H781-456	None									
		H781A-456	None									
		H782	None									
		H753A-456	None									
	G746A	H701B-456	None									
		H747-456	None									
		H781-456	None									
		H781A-456	None									
		H782	None									
	Lockbolt, Hydraulic Return	G83A, G84	H701B-456	744-300 <sup>1</sup>								
			H747-456	744-300 <sup>1</sup>								
H781-456			744-300 <sup>1</sup>									
H781A-456			744-300 <sup>1</sup>									
H782			744-300 <sup>1</sup>									
H753A-456		744-300 <sup>1</sup>										
G84	H84A-8	None										
Cherrylock, Double Action	G700	Cherrymax (See Above) <sup>2</sup>	680B205		2							
	G784	Cherrymax (See Above)	None									
	G700	H680B200A <sup>2</sup>	680B205		2							
	G784	H680B200A	None									
Nut Plate Riveters	G740A	H9040-4C	None									
		H9040-5C	None									
	G715A	H9015-3C	None									
		H9015-4C	None									
		H9015-5C <sup>2</sup>	None			2				2		

Notes: 1. Must remove the bayonette adaptor before using this adaptor; see Tool Manual for details.

2. Aluminum version only for this size because of power limitations.

3. This is a hand powered riveter.

# CHERRYMAX® INSTALLATION

In order to achieve proper fastener installations, make sure to:

- Prepare and de-burr the holes properly;
- Select the proper grips for the fasteners to be installed.

The following pages will describe each of these processes in detail.

1. Make sure the holes are aligned and the structure is properly clamped. Use Tack rivets and/or spring-loaded fasteners to minimize material creep and eliminate sheet gap.  
**Caution: This should be a clearance fit. Do not force the rivet into the hole!**
3. Place the pulling head (Installation tool) onto the rivet stem. Hold the tool coaxial with the hole the fastener is being installed into. Press firmly against head of rivet to minimize head and sheet gap.

4. Depress the trigger (or pump when using hand powered riveters). The rivet clamping action will pull the sheets together, seat the rivet head and break the stem flush with the head of the rivet. Release trigger after the stem breaks.

**Caution: Make sure to hold the riveter steady and coaxial with the rivet to be installed.**

A bulb will form on the blind side of the structure. During installation, the broken portion of the stem may be ejected through the back of the riveter; to contain the FOD, use the stem catcher bag (670A20) or the vacuum extraction accessory (RIVAC 220-03).

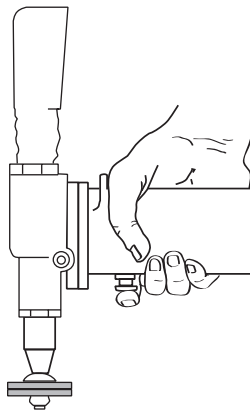
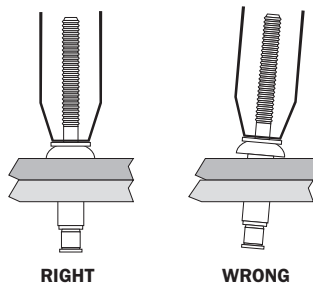
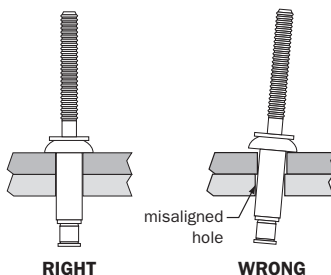



# HOLE PREPARATION

Proper hole preparation is critical for optimum fastener installation and joint properties.

## HOLE SIZE

Use the drill sizes in the table below to produce holes within the required limits.

Rivet Diameter	Drill Size	Min.	Max.
Nominal Diameter CherryMAX®			
1/8	#30	.129	.132
5/32	#20	.160	.164
3/16	#10	.192	.196
1/4	F	.256	.261
Oversize Diameter CherryMAX®			
1/8	#27	.143	.146
5/32	#16	.176	.180
3/16	#5	.205	.209
1/4	I	.271	.275

Rivet Diameter	Hole Gage Part Numbers	
	Nominal	Oversize
1/8	T172-4	T172-400
5/32	T172-5	T172-500
3/16	T172-6	T172-600
1/4	T172-8	T172-800

Always inspect with a Cherry® GO/NO-GO gage to assure drilling accuracy



Go

No-Go

## COUNTERSINK SIZE

Rivet Diameter	MS20426 100° Head		NAS1097 100° Head	
	C min.	C max.	C min.	C max.
-4 (1/8")	.222	.228	.189	.195
-5 (5/32")	.283	.289	.240	.246
-6 (3/16")	.350	.356	.296	.302
-8 (1/4")	.473	.479	.389	.395
Rivet Diameter	Unisink 100° Head		120° Head	
	C min.	C max.	C min.	C max.
-4 (1/8")	.167	.173	.269	.275
-5 (5/32")	.210	.216	.311	.317
-6 (3/16")	.252	.258	.347	.353
-8 (1/4")	—	—	—	—

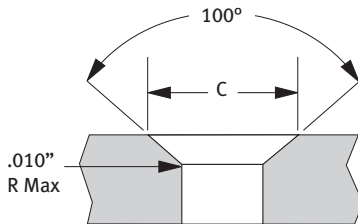

# HOLE PREPARATION

## DRILLING PROCEDURE

1. Use a clean, sharp, properly ground drill. Improperly ground drills will create oval or oversize holes.

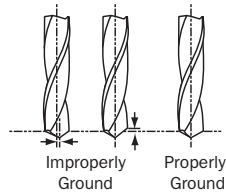

2. Center the drill in the chuck so that the drill will run true. A "wobble" in the drill will create an oversize hole.

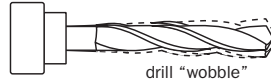

3. Clamp the structure together using spring loaded and hole filling tacking fasteners; this will ensure proper alignment and prevent burrs and chips being generated between the sheets.

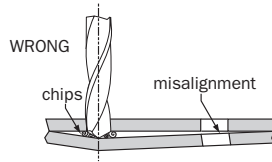
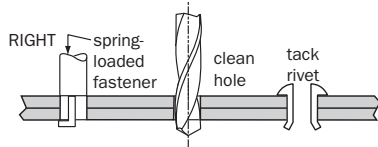

4. Hold the drill perpendicular to the surface being drilled. Do not force the drill through the material.

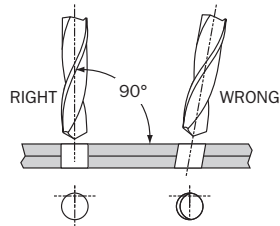

# HOLE PREPARATION

## DE-BURRING

After drilling it is advisable to remove the burrs and metal chips generated between the sheets and on the exit side of the structure. Here are some tips for effective and correct de-burring:

- De-burr carefully, especially on the blind side.
- Do not break the edge of hole as this may negatively impact installation and clamp-up.
- Keep in mind that minor burrs are OK and will not impact fastener installation and joint properties.

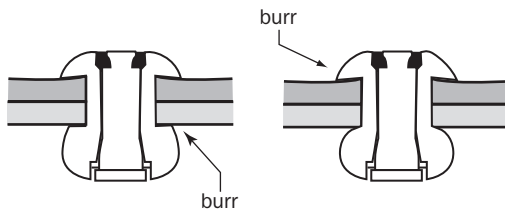
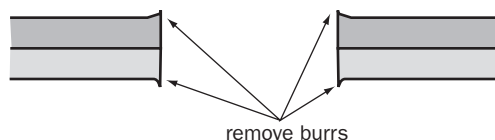
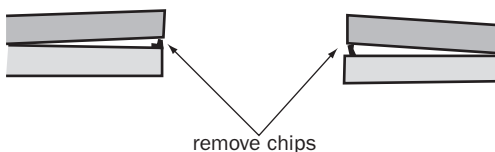

# HOLE PREPARATION

## COUNTERSINKING

Accurate countersinking is of primary importance to the structural integrity of a flush riveted joint.

Standard countersinking procedures (similar to the ones used for solid rivets) may be used.

The countersink tool pilot should be no more than .001" smaller than the hole diameter; a combination drill and countersink would improve accuracy.

Please note that an undersized pilot:

- May generate an off center countersink. This will create a head gap when installing the fastener.
- May cause off axis (angular) countersinks. This will create a "cocked" rivet head condition, causing installation issues.

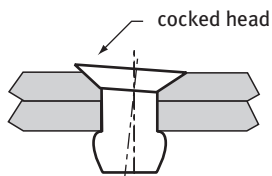
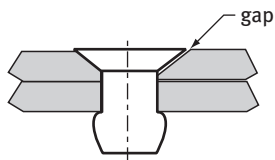

## DIMPLING

The CherryMAX® blind fasteners are especially recommended for this type of application.

In order to achieve the desired results, dimpling must be done with a hole-size allowing for subsequent reaming.

After dimpling, the hole should be reamed to the recommended dimensions.

This process is required as normal dimpling procedures stretch and enlarge the pilot holes in thin sheet applications, potentially causing installation issues.

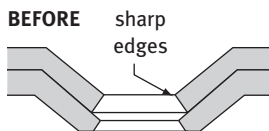

As Dimpled

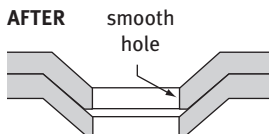

Hole Reamed

# CORRECT GRIP MEASUREMENT

In order to determine the proper fastener grip, it is recommended to measure the structure thickness at the hole-location with the CherryMAX® (269C3) grip gage (see below).

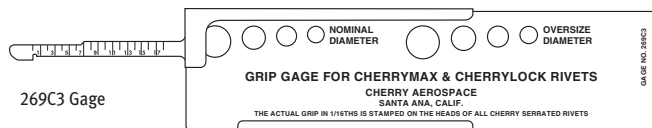

The gradations on the measuring end represent the grip of the fastener to be selected; the in-between gradations represent even grips (2, 4, 6 etc.).

## GRIP GAGE USE

1. Place gage into the prepared hole. Make sure the hook end is on the blind side, outside the hole.
2. Touch blind end. Bring the hook-end close to the edge of the hole (see picture) and pull the gage towards the blind end of the structure until the hook contacts the structure.
3. Read the grip of the fastener to use. The reading should be done at the visible surface of the structure; if the structure is dimpled or countersunk, measure to the surface of the structure and not to the dimpled/countersunk.
4. Select the fastener with a grip equal to the next higher number. If the number reading is directly on a line you may use either that grip or the next higher one.

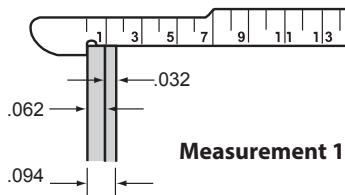

Measurement 1

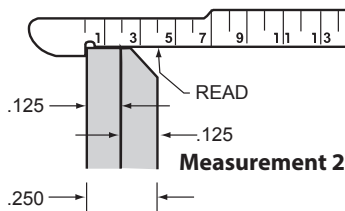

Measurement 2

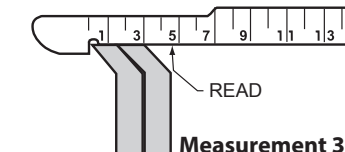

Measurement 3

## MEASUREMENT EXAMPLES:

- **Measurement 1** is typical for a protruding head fastener. 02 is the correct grip to be selected (in between gradations are even numbers).
- **Measurement 2** is typical for a flush head fastener. The correct grip is 04 or 05 because the structure aligns exactly with the 4 grip line.
- **Measurement 3** is a typical dimpled structure for a flush installation. The correct grip to be selected is 05 (the reading is between 4 and 5).

## PROPER SEALANT APPLICATION

Correct blind rivet installation is achieved by correct balance of installation forces as well as encountering some reaction from the structure. It is why correct hole preparation and proper clamping of the structure is critical for trouble free installation.

Sealant is incompressible, so when applied inside the hole it causes increased installation friction, potentially resulting in low-stem installations. If used in between the structure sheets, special care should be taken clamping the structure and using as many temporary fasteners as possible to ensure proper structure rigidity. Any sealant should be cleaned from inside the holes.

When used on the fastener, it should **ONLY** be applied around the rivet head (see illustration). It is critical that the sealant does not touch the exposed areas of the stem.

If sealant is incorrectly applied, two types of failures may occur:

- Stem breaks high or pulls through because sealant applied on the blind side decreased friction.
- Stem breaks low because sealant was applied inside the hole increasing friction or too much sealant was applied in between the structure sheets improperly clamping it, causing the joint to soften significantly.

In either case, the rivets must be removed and replaced.

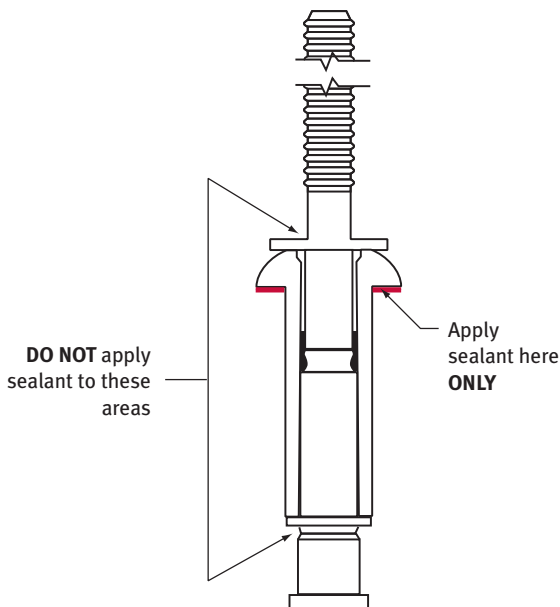

# RIVET SHAVING

Typically, flush fasteners install essentially flush with the aircraft skin so shaving the stem is not normally necessary.

However, in case of tighter flushness requirements, the stem may be shaved down to the top of the rivet sleeve. **Caution: Shaving into the rivet head is not allowed!**

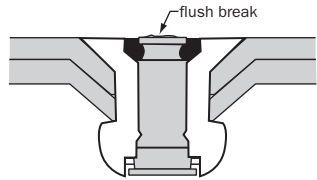

Before shaving, make sure that the stem protrusion is within the acceptable limits; a fastener having a stem protrusion higher than the acceptable limits must be removed and replaced, and not shaved in order to meet the flushness requirements.

# INSPECTION OF INSTALLED CHERRYMAX® FASTENERS

Inspection for the proper installation of CherryMAX® rivets is usually done from the visible side of the structure. Keep in mind that if your company has an internal inspection procedure, it will take precedence over the instructions provided in this document.

Typically, the following should be checked:

- Check if the correct rivet type, diameter (nominal or oversize) and grip size were used.
- Check for head deformation or gaps under the head.
- Check the stem protrusion and locking collar flushness.

## VISUAL INSPECTION

### Rivet Head Identification

The Stem and Rivet Materials and Grip Range are marked on the head of the fastener and are visible after installation.

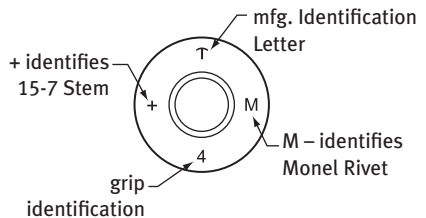

# INSPECTION OF INSTALLED CHERRYMAX® FASTENERS

## DRIVING ANVIL COLOR

The color of the driving anvil (removed during installation) indicates whether the fastener is nominal or oversize.

- Nominal: Gold color
- Oversize: Silver color

Superficial stretch marks which may appear in the rivet sleeve are not detrimental to rivet strength and are acceptable (bulb side shown).

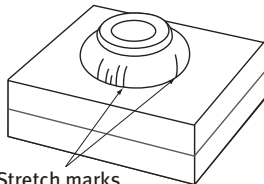
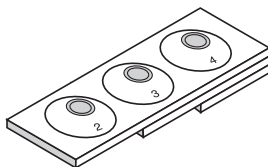

Stretch marks  
(acceptable)

## ACCEPTABLE BLIND HEAD FORMATIONS

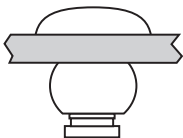

Typical Min. Grip

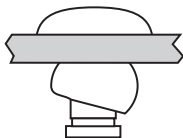

Irregular Formation Min. Grip

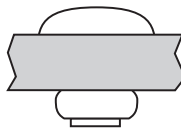

Typical Max. Grip

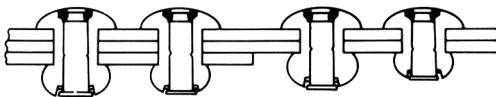

Aluminum  
Max. Grip

Monel  
Min. Grip



# INSPECTION OF INSTALLED CHERRYMAX® FASTENERS

## STEM AND COLLAR FLUSHNESS

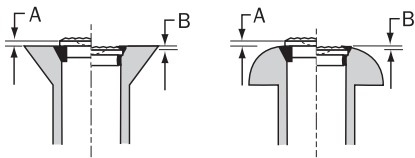

The Locking Collar must be flush or under-flush with the top surface of the rivet head. Collar flash permissible is .005 max.

Stem flushness shall be as indicated in the table on the right. Flushness measurement is

done from the top surface of the rivet to the smooth area of the stem around the break (the break-notch).

Rivet Dia.	A Max.	B Max.
-4 (1/8")	.010"	.015"
-5 (5/32")	.010"	.020"
-6 (3/16")	.010"	.020"
-8 (1/4")	.015"	.025"

## RIVET INSTALLATION TROUBLESHOOTING

When the instructions contained in this manual are carefully followed, the CherryMAX® fasteners should install without any problems.

To ensure optimum operation, make sure that the pulling heads and jaws are in good working condition:

- Clean (free from chips, burrs and dry sealant)
- Properly serviced and adjusted
- Are free from signs of wear

Use the following troubleshooting guide if installation issues arise.

### **PROBLEM: RIVET STEM BREAKS HIGH (OVER "A" MAX) OR FAILS TO BREAK**

**Source of the problem:** Rivet installed in an oversized hole.

Double check the hole sizes and use correct drill size for rivet to be installed.

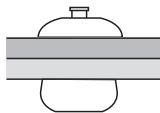

# RIVET INSTALLATION TROUBLESHOOTING

## PROBLEM: RIVET STEM BREAKS LOW (OVER “B” MAX)

### Source of the problem:

#### A. Poor hole preparation

- Undersize hole—enlarge the holes to proper size.
- The hole is slanted, misshapen or misaligned—follow carefully the “hole-preparation” techniques given in this manual.

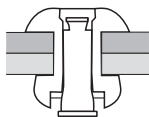

#### B. Wrong grip selection (rivet too short). Use a longer grip rivet.

- #### C. The joint is too soft—make sure that the structure is securely clamped, enough temporary fasteners are used and, if using sealant, it is applied correctly.

- #### D. Tool not coaxial to the hole during installation. Make sure to align the tool and keep arm flexible to avoid side loading the fastener.

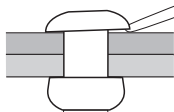

## PROBLEM: GAP UNDER THE RIVET HEAD

### Source of the problem:

#### A. Poor hole preparation

- The holes are slanted or misaligned.
- The countersink is not coaxial with the hole.

Fix: re-drill the holes carefully following the techniques given in this manual.

- #### B. Tool held slanted during installation, Hold the tool in a flexible manner and try to keep coaxial to the hole to avoid side loading.

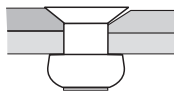

# RIVET REMOVAL

If rivet removal is necessary, the following procedures may be used:

- 1. Center-punch the stem.** This will provide a guide for the subsequent drilling.
- 2. Drill out the lock.** Use a small center drill first to provide a guide for a larger drill. Drill down to below the locking collar to destroy the lock.
- 3. Punch the stem out.** Use a steel punch to push the stem out through the blind side.
- 4. Drill out the rivet head.** Drill the head using a drill the same size as the rivet shank; be careful not to touch the structure.
- 5. Break off rivet head** using a pin punch prying it side to side.
- 6. Punch out the rivet body.** Drive out the remaining rivet with a pin punch.

**Caution: DO NOT drill completely through the rivet sleeve to remove a rivet as this may enlarge the hole.**

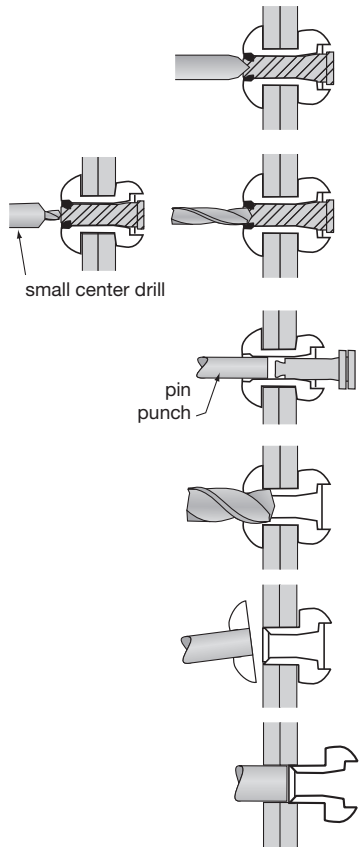

# CHERRYMAX® TOOLING

CherryMAX® is a complete fastening system, consisting of a wide variety of fasteners and related tools to install them. For optimum results it is important to use the Cherry recommended tooling.

## G800 HAND POWERED RIVETER

An ergonomic, lightweight hand powered riveter capable of installing a wide variety of blind type fasteners. The all metal design makes this compact tool ideal for use in repair facilities and field repair. The exceptional power multiplication provides up to 5000 lbs. of pulling force. It combines the safe and smooth operation of well-known pneumatic hydraulic riveters with our latest research in automatic systems.

It features a high strength steel CherryMAX® mounting system (same as G704B) compatible with our most popular pulling heads such as H782, H781, H753A-456, and can install a wide variety of blind fastener styles, diameters, head configurations, and material combinations.

## SPECIFICATIONS:

<b>Weight</b>	(no pulling head) 2.0 lbs (0.9 kg)
<b>Pulling Force</b>	up to 5000 lbs (22,2 kN)
<b>Stroke</b>	3/4" minimum (19 mm)

G800



G800 CMR Kit



# CHERRYMAX® TOOLING

The CherryMAX® pneumatic-hydraulic riveters are designed for the most efficient installation of CherryMAX® rivets. A durable, all metal housing makes these extremely robust tools ideal for use in rugged shop environments.

## G747 SPECIFICATIONS:

<b>Air pressure</b>	90–110 psi (6,2-7,6 bar)
<b>Stroke</b>	0.437 inch (11,1 mm)
<b>Pulling Force</b>	2100 lbs.@ 90 PSI (9,34 kN @ 6,2 bar)
<b>Weight</b>	3.5 Pounds (1,59 kg)

## G746A SPECIFICATIONS:

<b>Air pressure</b>	90–110 psi (6,2-7,6 bar)
<b>Stroke</b>	0.875 inch (22,2 mm)
<b>Pulling Force</b>	1850 lbs.@ 90 PSI (8,23 kN @ 6,2 bar)
<b>Weight</b>	4.25 lbs. (1,93 kg)

## G704B, G704B-SR AND G704B-40SH SPECIFICATIONS:

<b>Air pressure</b>	90–110 psi (6,2-7,6 bar)
<b>Stroke</b>	0.5 inch (12,7 mm)
<b>Pulling force</b>	3100 lbs. @ 90 PSI (13,79 kN @ 6,2 bar)

<b>Weight</b>	
<b>G704B</b>	4.25 lbs. (1,95 kg)
<b>G704B-SR</b>	<b>Hand held Unit:</b> <2.0 lbs. (0,9 kg) <b>Handle (floor unit):</b> <4 lbs. (1,81 kg)
<b>G704B-40SH</b>	<b>Hand held Unit:</b> 2.5 lbs. (1,13 kg) <b>Handle (floor unit):</b> 5.3 lbs. (2,4 kg)



# CHERRYMAX® TOOLING

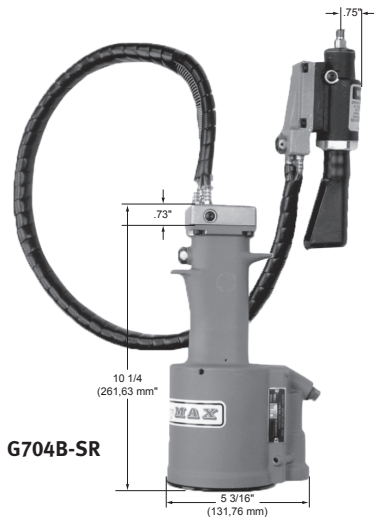

**G704B-SR**



**G704B-40SH**

## PULLING HEADS

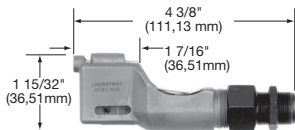

**H781-456 Offset Pulling Head**  
**H781A-456 Adjustable Grip**  
**Offset Pulling Head**

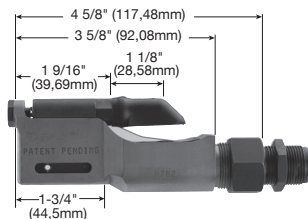

**H782 Two Jaw Offset Pulling Head**

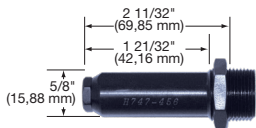

**H747-456**  
**Compact Universal Head**

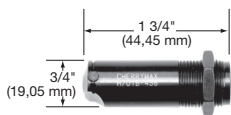

**H701B-456**  
**Straight Pulling Head**

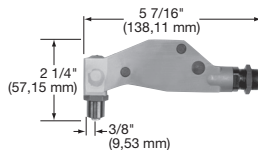

**H753A-456**  
**Right Angle Pulling Head**

## CHERRYMAX® TOOLING (-8 DIAMETER)

The Cherry pneumatic-hydraulic power assisted (hydraulic) return riveters (G84) are primarily Lockbolt® riveters, but they are also used for installing the -8 diameter CherryMAX® rivets.

A durable, all metal housing makes these extremely robust tools ideal for use in rugged shop environments. These tools are very versatile, as they can be used for installing CherryMAX®, Lockbolt® and Maxibolt® fasteners.

### G84 SPECIFICATIONS:

**Air Pressure** 90-110 psi (6,2-7,6 bar)

**Stroke** 0.562 inch (14,28 mm)

**Pulling Force** 5750 lbs. @ 100 PSI  
(26,1 KN @6.89 bar)

**Return Force** 1200 lbs. @ 100 PSI  
(5,4 KN @6.89 bar)

**Weight** 7.7 lbs. (3,49 kg)

### H84A-8 PULLING HEAD (sold separately)

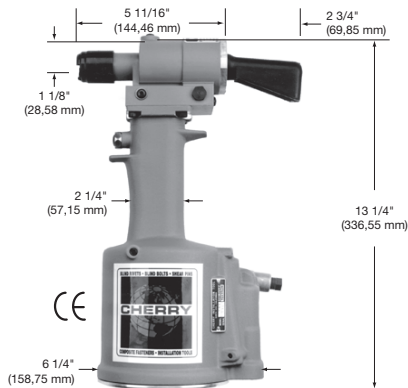
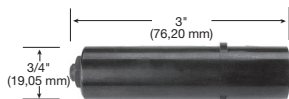

## CHERRYLOCK® DOUBLE ACTION RIVETERS

The use of these riveters is not preferred, however if one is available, there are the following choices:

- H680B200A pulling head will work directly on these riveters and will install -4, -5 and -6 diameter CherryMAX®.
- 680B205 adapter will allow use of the Cherrymax pulling heads (Ex: H781-456 and H753A-456) with these riveters.

G700 may be used for -4 diameter only,

G784 may be used for -4, -5 and -6 diameters.



## EXTENSIONS, ADAPTORS & ACCESSORIES

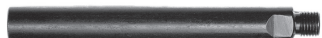

### 704A12- 2, 4, 6, 12" EXTENSIONS

These extensions help reach restricted installation areas otherwise too deep to reach. The extension is represented by the dash after the part number:

- 704A12-2 (2" extension)
- 704A12-4 (4" extension)
- 704A12-6 (6" extension)
- 704A12-12 (12" extension)



### 744-300 ADAPTOR

This adaptor is necessary when using Cherrymax pulling heads (H701B, H753A etc.) on the G83 and G84 riveters.



### 704A6 ADAPTOR

This adaptor is necessary when using H9040 pulling heads (for Nut Plate rivets) with the Cherrymax riveters.



### 704A9 ADAPTOR

This adaptor is necessary when using H9015 pulling heads (for Nut Plate rivets) and H9055 pulling heads (Cherrylock A code) with the Cherrymax riveters.



### 670A20 STEM CATCHER

The stem catcher bag helps contain the spent stems reducing FOD.

This heavy bag snaps over the stem deflector and works with the G704B, G746A, G747, G83A and G84 riveters.

### RIVACT™ 220-03 VACUUM STEM COLLECTION SYSTEM

This accessory may be used instead of the Stem Catcher bag in order to extract spent stems and control FOD.





# TOOL TROUBLESHOOTING

Cherry installation tools are manufactured to give maximum service with minimum care. In order to accomplish this, follow these basic recommendations.

1. The tools must be “bled” and serviced regularly (see tool manuals for details).
2. Regulated, clean and dry air should be used; dirty or moist air will cause premature wear.
3. Do not pound on the rear of the tool head to force rivets into holes, as this will damage the tool.
4. Make sure the pulling head is correctly and securely attached.

## PNEUMATIC TOOLS

**1. Check air supply:** Make sure the riveter is connected and that the air pressure is within the recommended range (90 To 110 PSI).

**2. Bleed the air out:** Use 700A77 filled with Transmission Fluid (ATF) per tool manual instructions.

### 3. Check for fluid leaks:

- A. Fluid leaks around the cap screws **2** at the head indicates that the screws are loose or the washer gaskets **3** need replacing.
- B. A fluid leak through the by-pass hole at the base of the handle **34** indicates that the internal seals are worn or damaged.
- C. A Fluid leak from the front of the head **1** indicates that piston seals are worn or damaged.

**5. Check valve **45** for air leakage:** if air leaks without depressing trigger **29** the trigger valve seals are worn out or damaged.

**6. Check piston stroke:** If the piston is stuck back or it is short of stroke, the tool must be serviced.

**7. Check tool speed:** If it is slow to respond, the muffler or air filter inside spool **45** may be clogged with dirt. Clean thoroughly with normal solvent and back- blow with compressed air.

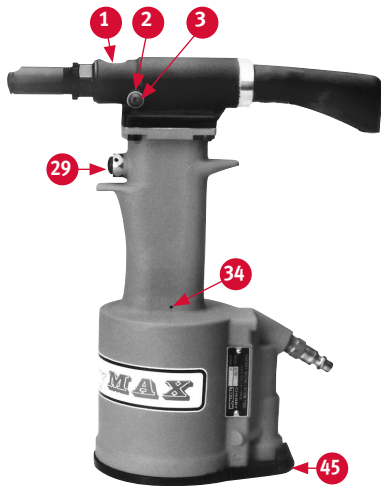

# HAND RIVETERS

The G800 riveter was designed to be robust and require minimum troubleshooting and maintenance.

In order to keep it in optimum operating condition, inspect routinely for leaks and damage and check the fluid level. Please refer to the tool manual for more detailed troubleshooting tips and service instructions.

**Problem: The stem of the fastener to be installed won't fit**

- Make sure the correct pulling head is used, and that it is properly adjusted (the jaws should free the broken stem when the side button is depressed).
- Check for jammed stems inside the jaws; press the side button to properly eject the stem.

**Problem: The stems will not break to complete the installation**

- Check the jaws- replace or clean them as necessary.
- Make sure that the proper pulling head and optional components are used.
- Check the fluid level; replenish if low.

**Problem: Nothing happens when I pump**

- Check the fluid level –add fluid as needed.
- Re-adjust the pressure valve to increase output load.
- Service or replace the pressure relief valve; disassemble and clean thoroughly the internal components; debris or contamination in the fluid will cause the internal valves to malfunction.



## SERVICE ACCESSORIES:

### THE 700A77 AIR BLEEDER

Bleeding the hydraulic system regularly is critical for optimum tool service and extended tool life.

The 700A77 Cherry® air bleeder may be used on any of the Cherry® power riveters and will quickly bleed the air and refill the hydraulic system.

## TOOL & REPAIR SERVICE

Regular service and maintenance of the riveters is critical for a trouble free operation and for an extended tool life. In order to service or repair the tools, you will need:

- **Tool Kit:** Contains all the special tools necessary to repair/ service the riveter.
- **Service Kit:** Includes all the seals, screws, gaskets and other items to be replaced.

Please check with the Tool Manual for the latest information.

### FOR THE MOST POPULAR CHERRYMAX RIVETERS: TOOL AND SERVICE KITS (700A77 Air Bleeder included)

Cherry® Tool	Tool Kit	Service Kit
G704B	G701/G704KT	G704KS
G704B-SR	G701/G704KT	G704KS
G704B-SH	G740KT	G704B-40SR/40SHKS
G744	G740KT	G744KS
G746A	G701/G704KT	G746AKS
G747	G701/G704KT	G747KS
G83	G701/G704KT	G83KS
G-83A	G701/G704KT	G83AKS
G84	G740KT	G84KS



**700A77 Air Bleeder**

**NOTE:** Only use Dextron III ATF in Cherry® power riveters.

### TYPICAL TOOLS INCLUDED IN KITS



**700B65 Packing Plug Wrench**

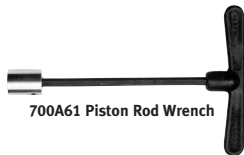

**700A61 Piston Rod Wrench**



**700A62 Power Cylinder Tool**

# DECIMAL EQUIVALENT CHART

Nom.	M/M	Dec.	Nom.	M/M	Dec.	Nom.	M/M	Dec.	Nom.	M/M	Dec.	Nom.	M/M	Dec.
—	.1	.0039	1/16	—	.0625	21	—	.1590	K	—	.2810	9/16	—	.5625
—	.2	.0079	52	—	.0635	20	—	.1610	9/32	—	.2812	37/64	—	.5781
—	.3	.0118	51	—	.0670	19	—	.1660	L	—	.2900	—	15.0	.5906
80	—	.0135	50	—	.0700	18	—	.1695	M	—	.2950	19/32	—	.5937
79	—	.0145	49	—	.0730	11/64	—	.1719	19/64	—	.2969	39/64	—	.6094
1/64	—	.0156	48	—	.0760	17	—	.1730	N	—	.3020	5/8	—	.6250
—	.4	.0157	5/64	—	.0781	16	—	.1770	5/16	—	.3125	—	16.0	.6299
78	—	.0160	47	—	.0785	15	—	.1800	—	8.0	.3150	41/64	—	.6406
77	—	.0180	—	2	.0787	14	—	.1820	O	—	.3160	21/32	—	.6562
—	.5	.0197	46	—	.0810	13	—	.1850	P	—	.3230	—	17.0	.6693
76	—	.0200	45	—	.0820	3/16	—	.1875	21/64	—	.3281	43/64	—	.6719
75	—	.0210	44	—	.0860	12	—	.1890	Q	—	.3320	11/16	—	.6875
74	—	.0225	43	—	.0890	11	—	.1910	R	—	.3390	14/84	—	.7031
—	.6	.0236	42	—	.0935	10	—	.1935	11/32	—	.3437	—	18.0	.7087
73	—	.0240	3/32	—	.0937	9	—	.1960	S	—	.3480	23/32	—	.7187
72	—	.0250	41	—	.0960	—	5.0	.1968	—	9.0	.3543	47/64	—	.7344
71	—	.0260	40	—	.0980	8	—	.1990	T	—	.3580	—	19.0	.7480
—	.7	.0276	39	—	.0995	7	—	.2010	23/64	—	.3594	3/4	—	.7500
70	—	.0280	38	—	.1015	13/64	—	.2031	U	—	.3680	49/64	—	.7656
69	—	.0292	37	—	.1040	6	—	.2040	3/8	—	.3750	25/32	—	.7812
68	—	.0310	36	—	.1065	5	—	.2055	V	—	.3770	—	20.0	.7874
1/32	—	.0312	7/64	—	.1094	4	—	.2090	W	—	.3860	51/64	—	.7969
—	.8	.0315	35	—	.1100	3	—	.2130	25/64	—	.3906	13/16	—	.8125
67	—	.0320	34	—	.1110	7/32	—	.2187	—	10.0	.3937	—	21.0	.8268
66	—	.0330	33	—	.1130	2	—	.2210	X	—	.3970	53/64	—	.8281
65	—	.0350	32	—	.1160	1	—	.2280	Y	—	.4040	27/32	—	.8437
—	.9	.0354	—	3.0	.1181	A	—	.2340	13/32	—	.4062	55/64	—	.8594
64	—	.0360	31	—	.1200	15/64	—	.2344	Z	—	.4130	—	22.0	.8661
63	—	.0370	1/8	—	.1250	—	6.0	.2362	27/64	—	.4219	7/8	—	.8750
62	—	.0380	30	—	.1285	B	—	.2380	—	11.0	.4331	57/64	—	.8906
61	—	.0390	29	—	.1360	C	—	.2420	7/16	—	.4375	—	23.0	.9055
—	1	.0394	28	—	.1405	D	—	.2460	29/64	—	.4531	29/32	—	.9062
60	—	.0400	9/64	—	.1406	1/4	—	.2500	15/32	—	.4687	59/64	—	.9219
59	—	.0410	27	—	.1440	E	—	.2500	—	12.0	.4724	15/16	—	.9375
58	—	.0420	26	—	.1470	F	—	.2570	31/64	—	.4844	—	24.0	.9449
57	—	.0430	25	—	.1495	G	—	.2610	1/2	—	.5000	61/64	—	.9531
56	—	.0465	24	—	.1520	17/64	—	.2656	—	13.0	.5118	31/32	—	.9687
3/64	—	.0469	23	—	.1540	H	—	.2660	33/64	—	.5156	—	25.0	.9842
55	—	.0520	5/32	—	.1562	I	—	.2720	17/32	—	.5312	63/64	—	.9844
54	—	.0550	22	—	.1570	—	7.0	.2756	35/64	—	.5469	1	25.4	1.000
53	—	.0595	—	4.0	.1575	J	—	.2770	—	14.0	.5512	—	—	—

# NAS VS. CHERRYMAX® CROSS-REFERENCE LIST

NAS	Cherry®
NAS9301B-x-xxx	CR3213-x-xxx
NAS9301E-x-xxx	CR3223-x-xxx
NAS9302B-x-xx	CR3212-x-xx
NAS9302E-x-xx	CR3222-x-xx
NAS9303B-x-xx	CR3214-x-xx
NAS9303E-x-xx	CR3224-x-xx
NAS9304B-x-xx	CR3243-x-xx
NAS9304E-x-xx	CR3253-x-xx
NAS9305B-x-xx	CR3242-x-xx
NAS9305E-x-xx	CR3252-x-xx
NAS9306B-x-xx	CR3245-x-xx
NAS9306E-x-xx	CR3255-x-xx
NAS9307M-x-xx	CR3523-x-xx
NAS9307ML-x-xx	CR3523P-x-xx
NAS9307MN-x-xx	CR3523EE-x-xx
NAS9307MP-x-xx	CR3523P-x-xx or CR3523EE-x-xx
NAS9308M-x-xx	CR3522-x-xx
NAS9308ML-x-xx	CR3522P-x-xx
NAS9308MN-x-xx	CR3522EE-x-xx
NAS9308MP-x-xx	CR3522P-x-xx or CR3522EE-x-xx
NAS9309M-x-xx	CR3524-x-xx
NAS9309ML-x-xx	CR3524P-x-xx

NAS	Cherry®
NAS9309MN-x-xx	CR3524EE-x-xx
NAS9309MP-x-xx	CR3524P-x-xx or CR3524EE-x-xx
NAS9310C-x-xx	CR3853-x-xx
NAS9310M-x-xx	CR3553-x-xx
NAS9310ML-x-xx	CR3553P-x-xx
NAS9310MN-x-xx	CR3553EE-x-xx
NAS9310MP-x-xx	CR3553P-x-xx or CR3553EE-x-xx
NAS9311C-x-xx	CR3852-x-xx
NAS9311M-x-xx	CR3552-x-xx
NAS9311ML-x-xx	CR3552P-x-xx
NAS9311MN-x-xx	CR3552EE-x-xx
NAS9311MP-x-xx	CR3552-x-xx or CR3552EE-x-xx
NAS9312M-x-xx	CR3555-x-xx
NAS9312ML-x-xx	CR3555P-x-xx
NAS9312MN-x-xx	CR3555EE-x-xx
NAS9312MP-x-xx	CR3555P-x-xx or CR3555EE-x-xx

**Note 1:** X represents the diameter code, in 1/32" increments (Example: -5 diameter is 5/32").  
XX represents the grip code (two digits) in 1/16" increments (Example: -4 grip is 4/16" max grip).

**Example:** NAS9301B-5-04 represents a fastener with a 5/32" diameter and 1/4" max grip.

## LIMITED WARRANTY

Seller warrants the goods conform to applicable specifications and drawings and will be manufactured and inspected according to generally accepted practices of companies manufacturing industrial or aerospace fasteners. In the event of any breach of the foregoing warranty, Buyer's sole remedy shall be to return defective goods (after receiving authorization from Seller) for replacement or refund of the purchase price, at the Seller's option. Seller agrees to any freight costs in connection with the return of any defective goods, but any costs relating to removal of the defective or nonconforming goods or installation of replacement goods shall be Buyer's responsibility. SELLER'S WARRANTY DOES NOT APPLY WHEN ANY PHYSICAL OR CHEMICAL CHANGE IN THE FORM OF THE PRODUCT IS MADE BY BUYER. THE FOREGOING EXPRESS WARRANTY AND REMEDY ARE EXCLUSIVE AND ARE IN LIEU OF ALL OTHER WARRANTIES AND REMEDIES; ANY IMPLIED WARRANTY AS TO QUALITY, FITNESS FOR PURPOSE, OR MERCHANTABILITY IS HEREBY SPECIFICALLY DISCLAIMED AND EXCLUDED BY SELLER. This warranty is void if seller is not notified in writing of any rejection of the goods within one (1) Year after initial use by buyer of any power Riveter or ninety (90) days after initial use of any other product.

Seller shall not be liable under any circumstances for incidental, special or consequential damages arising in whole or in part from any breach by Seller, AND SUCH INCIDENTAL, SPECIAL, OR CONSEQUENTIAL DAMAGES ARE HEREBY EXPRESSLY EXCLUDED.

Our policy is one of continuous development. Specifications shown in this document may be subject to changes introduced after publication.

Cherry® and CherryMAX® are trademarks of Cherry Aerospace.

### Note

The properties, strengths, dimensions, installed characteristics and all other information in this catalog is for guidance only to aid in the correct selection of the products described herein and is not intended or implied as part of the warranty. All applications should be evaluated for functional suitability and available samples of the described parts can be requested for installed tests, suitability and evaluations.

### Attention

Blind fasteners are not always a suitable substitute for solid shank fasteners. Maintenance personnel are reminded that AC 43.13-1A chapter 2, section 3, stipulates: "Do not substitute hollow rivets for solid rivets in load carrying members without specific approval of the application by a representative of the Federal Aviation Administration. Blind rivets may be used in blind locations in accordance with the conditions listed in Chapter 5, provided the edge distances and spacings are not less than the minimum listed in paragraph 99d."



**CHERRY**®  
AEROSPACE

1224 East Warner Avenue, Santa Ana, CA 92705  
voice: 714-545-5511 • fax: 714-850-6093  
[www.cherryaerospace.com](http://www.cherryaerospace.com)





**CHERRY<sup>®</sup>**  
**AEROSPACE**  
*SPS Fastener Division, a PCC Company*

1224 East Warner Avenue, Santa Ana, CA 92705  
voice: 714-545-5511 • fax: 714-850-6093  
[www.cherryaerospace.com](http://www.cherryaerospace.com)

©Cherry Aerospace  
Suppliers Federal I.D. Code 11815  
CA-1015 Rev: C Date: 2-3-15 CR#: 15-0054